**Lithium Ion Rechargeable Batteries
Technical Handbook**

Table of Contents

1 Overview of Batteries	7
1-1 Foreword	7
1-2 Features	7
1-3 Origin of battery name	7
1-4 Charge/ Discharge mechanism	9
1-5 Cathode	9
1-6 Anode	11
1-7 Battery construction and configuration	11 ~ 13
1-8 Method of manufacture	15
1-9 Environmental considerations	15
2 Battery Characteristics	17
2-1 Charge characteristics	17
2-2 Discharge characteristics	17
2-3 Storage characteristics	17
2-3-1 Self-discharge characteristics	17
2-3-2 Long-term storage characteristics	17
2-4 Charge/Discharge cycle characteristics	17
2-5 Performance data	19
2-5-1 Polymer (UP383562)	19 ~ 25
Lithium ion rechargeable batteries with lithium cobalt oxide cathodes and graphite anodes	
1. Charge characteristics; 2. Discharge characteristics;	
3. Storage characteristics; 4. Discharge characteristics at GSM pulse mode	
2-5-2 Graphite (US18650GR)	27 ~ 31
Lithium ion rechargeable batteries with lithium cobalt oxide cathodes and graphite anodes	
1. Charge characteristics; 2. Discharge characteristics; 3. Storage characteristics	
2-5-3 Hard carbon (US18650)	33 ~ 37
Lithium ion rechargeable batteries with lithium cobalt oxide cathodes and hard carbon anodes	
1. Charge characteristics; 2. Discharge characteristics; 3. Storage characteristics	
3 Safety	39
3-1 General safety	39
3-2 Safety mechanisms	39
3-3 Procedures to confirm safety and results	41 ~ 43
3-4 Regarding the electrolyte	45
4 Battery Modules	47
4-1 Battery modules	47
4-2 Protective circuitry within battery packs	47
4-2-1 Charge voltage regulation	49
4-2-2 Overdischarge voltage regulation	49
4-2-3 Overcurrent regulation	49
4-2-4 Temperature regulation	49
4-2-5 Redundant-protection circuitry	49
4-2-6 “ Chain short ” protection	49

4-2-7 Other protective circuitry	51
4-3 Operation of battery packs for PCs	51
4-3-1 Operating range of batteries for power supply systems	51
5 Charging Procedure	53
5-1 Recharger voltage per cell	53
5-2 Charge time	53
5-3 Temperature range during charging	53
6 Precautions in Handling and Use	55
6-1 Precautions in handling	55
6-1-1 Charging	55
6-1-2 Discharging	55
6-1-3 Equipment design	55
6-2 Precautions in use	57
6-2-1 Prohibitions relating to use	57
6-2-2 Charging	57
6-2-3 Discharging	57
6-2-4 Storage	57
6-2-5 Other matters	57
7 Safety Indications	59
7-1 Basic approach to indications	59
7-2 Objects of indications	59
7-3 Means for indications	61
7-4 Matters for indication	61 ~ 65
8 Indications on Acquisition of Safety Certification	67
8-1 Indications for UL1642 lithium batteries standards	67
8-1-1 Indications on battery pack	67
8-1-2 Indications on equipment using battery pack	67
8-2 CSA and EN standards	67
9 Glossary	69 ~ 73
10 Sales Office	75

1 Overview of Batteries

1-1 Foreword

1-1

Portable electronic equipment is moving toward increasing compactness and light weight, and we are on the threshold of the age of wearable equipment. In such circumstances the rechargeable batteries which power such equipment play an increasingly vital role, and in addition to demands for reduced size and weight, there are now also requests for performance necessary to support the sophisticated functions of modern equipment. In response to these needs, Sony has conducted development based on entirely novel concepts, and in 1991 released the world's first commercial lithium ion rechargeable battery product. In addition to a high energy density, this battery also offered excellent low-temperature characteristics, load characteristics and cycle characteristics. As a result, it quickly became an indispensable source of power for audio and video equipment, personal computers, portable telephones, and other portable equipment. And, Sony development efforts are advancing steadily toward the next generation of products, targeting new type lithium ion rechargeable batteries which are easier to use such as "polymer batteries" with polymerized electrolyte.

1-2 Features

1-2

- 1) Energy densities are high; the US18650 size attains the energy density per volume of approx. 440 Wh/l and the energy density per weight of approx. 160 Wh/kg.
- 2) Voltages are high, with average operating voltages at 3.6 V for hard carbon batteries and 3.7 V for graphite batteries; these are approximately three times the cutoff voltage of Ni-Cd and Ni-MH batteries.
- 3) Charge/discharge cycle characteristics are excellent; batteries can be put through 500 or more cycles.
- 4) Self-discharge is minimal, at under 10% per month.
- 5) There is no memory effect such as that in Ni-Cd and Ni-MH batteries.
- 6) Remaining capacity can easily be indicated using the discharge curve.
- 7) Carbon material, rather than metallic lithium or lithium alloy, is used as the anode material. The lithium ion state is maintained over a wide range of operating conditions, for excellent safety.
- 8) In accordance with using gel polymer electrolyte, laminated film can be used to outer equipment and, "thin" and "light" lithium ion rechargeable battery was achieved.
 - * Thickness is approx. 2.5mm at present. In future, achievement of 1mm or less is possible.
 - * According to using special gel polymer electrolyte, it become possible to supply no leak of the electrolyte and extremely high safety batteries.
 - * Development of big footprint cells become possible (xx5385 series like as 325385 etc.). That was impossible to usual lithium ion batteries.

1-3 Origin of battery name

1-3

In these batteries, carbon material is used in the anodes and a metal oxide material containing lithium is used in the cathodes; lithium ions migrate between the two electrodes via an organic electrolyte. By designing these batteries in accordance with the reversible capacity of the carbon material, lithium does not exist in the metallic state during either the charging or discharging processes.

In order to differentiate these batteries from those using metallic lithium or lithium alloy in the anode, we designated these devices lithium ion rechargeable batteries.

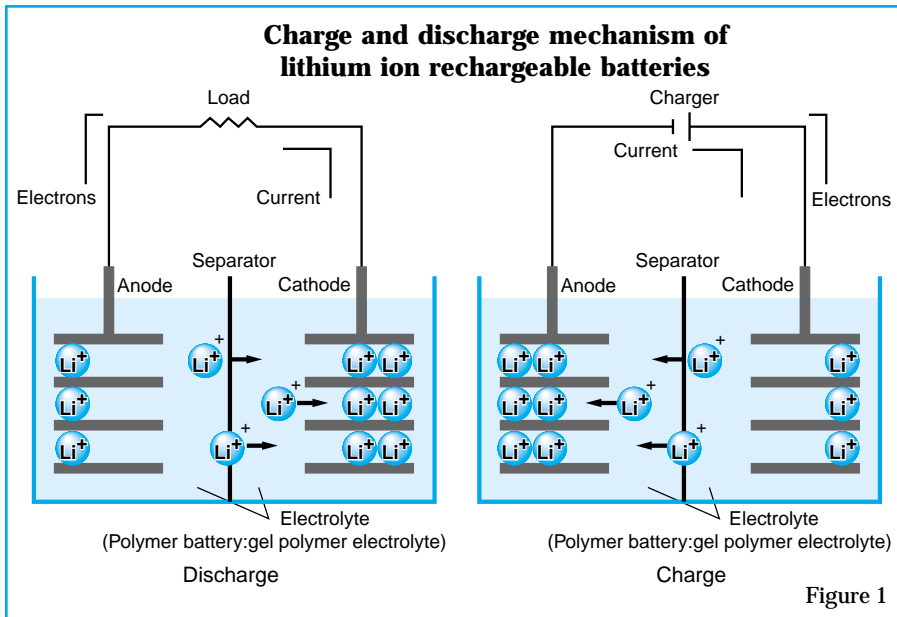

1-4 Charge/discharge mechanism

1-4

Battery charging and discharging occur through the migration of lithium ions between the cathodes and anodes and the exchange of electrons through doping and dedoping.

More specifically, during charging lithium is dedoped from cathodes consisting of a lithium-containing compound, and the interlayers of carbon in anodes are doped with lithium. Conversely, during discharge lithium is dedoped from between the carbon layers in anodes, and the compound layers in cathodes are doped with lithium. Reactions occurring in lithium ion rechargeable batteries employing LiCoO_2 (lithium cobaltate) in cathodes and carbon in anodes are shown in Figure 1.

By means of the initial charging, which takes place during battery manufacture, lithium ions migrate from the lithium compound of the cathode to the carbon material of the anode.

initial charge

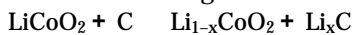

Subsequent discharge reactions occur through the migration of lithium ions from the anode to the cathode.

discharge

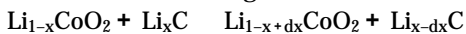

charge

1-5 Cathodes

1-5

Compounds containing lithium ions and which can be used as the cathode active material must be capable of dedoping lithium during charge, and undergo lithium doping during discharge. Candidate compounds include LiCoO_2 (lithium cobaltate), LiNiO_2 (lithium nickelate), and LiMn_2O_4 (spinel-structure lithium manganate). On comparing the characteristics of these compounds, LiCoO_2 was selected for use as the first generation's cathode active material due to its reversibility, discharge capacity, charge/discharge efficiency, discharge curve and other properties. At present employing of $\text{LiNi Co}_x\text{O}_2$ was achieved. LiMn_2O_4 is also being studied.

In order to use carbon material in anodes to obtain batteries with a high energy density, the lithium storage capability of the anode carbon material must be enhanced. Carbon materials with large doping capacities, and the possibility of lithium-carbon intercalation complexes exceeding the LiC_6 stoichiometric composition, are being studied.

The following three types of carbon material have been employed in anodes.

- (1) Graphite
- (2) Graphitizable carbon (soft carbon)
- (3) Nongraphitizable carbon (hard carbon)

In hard carbon, the interlayer distances are large compared with those in graphite and soft carbon, and reversibility in charging and discharging is good, for excellent cycling characteristics. In addition, floating charge characteristics during charging are also satisfactory. And such materials have a sloping discharge curve, so that by measuring the battery voltage the remaining capacity can be easily determined.

On the other hand, graphite materials have a little working voltage by the depth of discharge and exhibit excellent characteristics in constant-power discharge. When the lithium ion battery with nickel cathode material and graphite anode is used, such materials have a sloping discharge curve, so that the remaining capacity can be easily indicated like as hard carbon anode battery.

In our research, it was confirmed that lithium in hard carbon and graphite materials always remains in the ionic state, and does not exist in the metallic state.

1-7 Battery construction and configuration

Battery constructions are illustrated in Figure 2.

Polymer

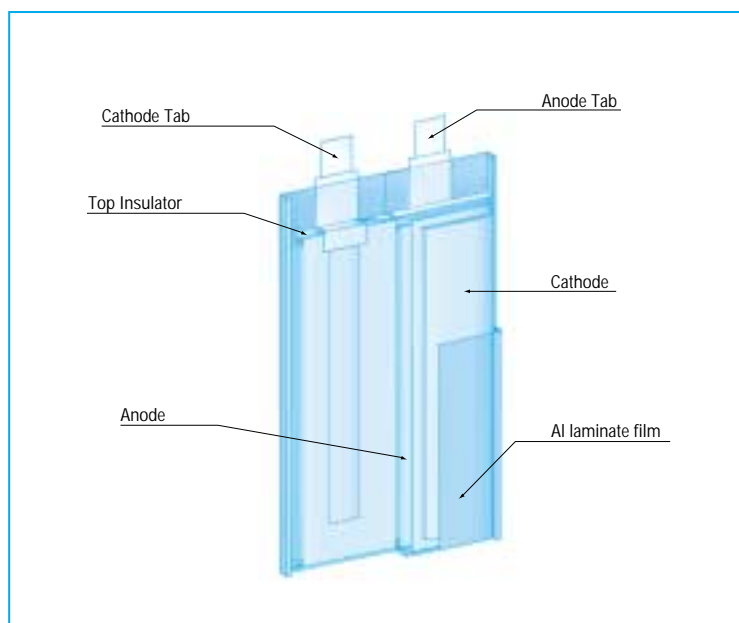
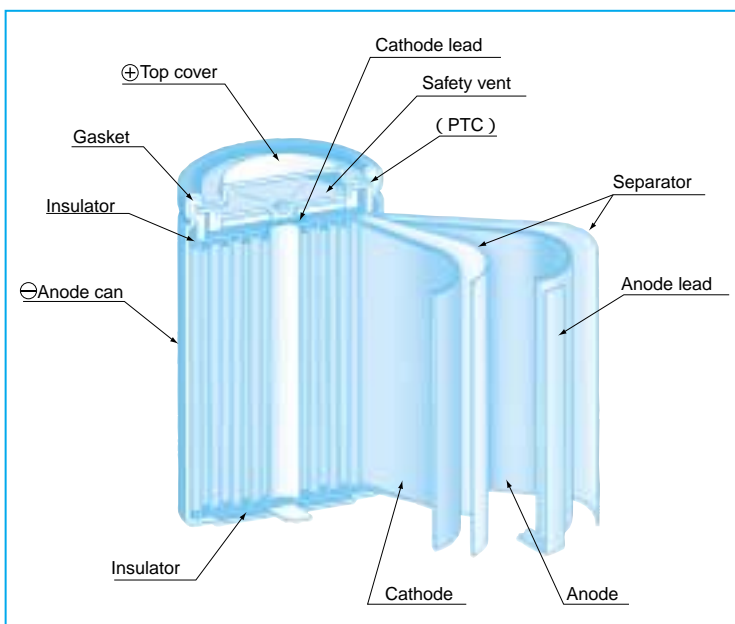

Figure 2

Cylindrical



Prismatic

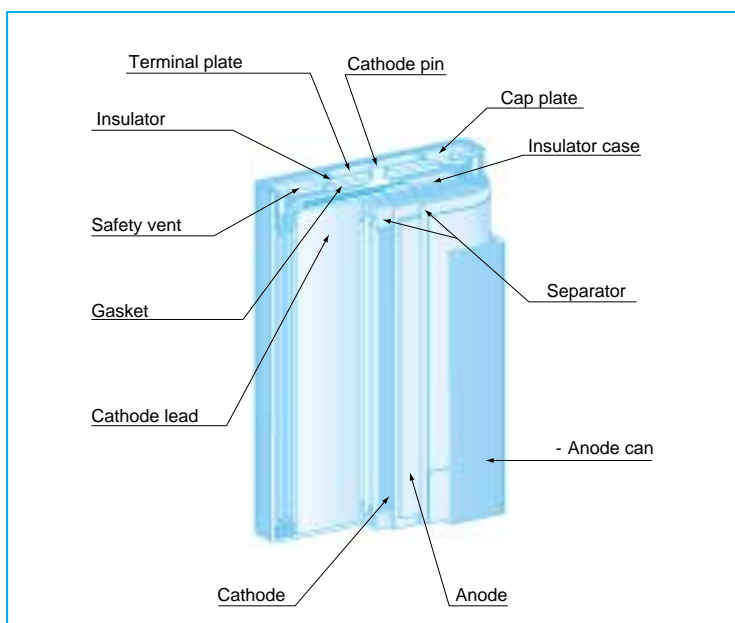

Figure 2

As for cylindrical and prismatic batteries, sheet like cathodes and anodes are wound together in a spiral shape. Between the cathodes and anodes is wound a polymer separator film which acts to obstruct micropores and interrupt the reaction should the cell temperature rise excessively for some reason. In order to ensure cell safety, for example, the cylindrical battery incorporates a safety mechanism consisting of a circuit breaker, rupture disk, and PTC (positive temperature coefficient) device. The electrolyte is an organic solvent which is stable up to high voltage, in which a lithium salt is dissolved.

As for polymer batteries, there are gel polymer electrolyte between cathodes and anodes. Other parts are of very simple constructions.

In order to ensure superior characteristics, batteries are manufactured in a rigorously controlled environment using carefully maintained equipment. Manufacturing processes can be broadly divided into three stages: electrode material production process, assembly process, and charge-discharge process.

Electrode production process: The electrode active materials are used to manufacture the electrode mixtures. These mixtures are then used to uniformly coat both sides of a thin metal foil. The amount of electrode mixture applied has a considerable influence on battery performance, and control of the amount of coated material is crucial.

Assembly process: In batteries where lithium ions figure in battery reactions, elimination of all water content is mandatory. All battery components are dried thoroughly, and batteries are assembled inside a dry room held at low humidity.

Charge-discharge process: In the initial charging, lithium ions move from the cathode to the anode, and the device begins to function as a battery. Prior to shipment the discharge capacity is measured, and cells with similar performance are combined in battery packs.

In March 1997, Sony Fukushima Corporation(former Sony Energytech Inc.), the main business unit manufacturing lithium ion rechargeable batteries, was the first company in the Japanese battery industry to obtain ISO14001 certification, reflecting ongoing efforts to alleviate environmental impact. At present, all Sony business units involved in the manufacture of lithium ion rechargeable batteries are ISO14001-certified, and are promoting activities for the preservation of the global environment.

In addition, Sony is conducting development of technology for recycling of lithium ion rechargeable batteries jointly with Sumitomo Metal Mining Co., Ltd., and in April 1996 announced completion of the world's first recycling system. Subsequent to this, recovery of used lithium ion rechargeable batteries was begun in Japan.

Through these activities, Sony is alleviating the environmental burden imposed by lithium ion rechargeable batteries, and is promoting reuse of valuable resources in used batteries

2 Battery Characteristics

2-1 Charge characteristics

2-1

The cathode potential is determined by the amount of lithium dedoped from the LiCoO_2 or $\text{LiNiCo}_x\text{O}_2$ cathode active material. Put another way, if a battery is charged without setting an upper limit voltage, more lithium ions than are necessary migrate to the anode, and the battery performance is undesirable for safety reasons. Hence in this battery system, charging is as a rule performed under constant-voltage, constant-current control. The maximum proper charging voltage for Sony's lithium ion rechargeable batteries is 4.2 V.

2-2 Discharge characteristics

2-2

The discharge voltage is initially approx. 4 V, and even on average remains high at approx. 3.6 V for hard carbon batteries and approx. 3.7 V for graphite batteries; these figures are three times the values of nickel cadmium rechargeable batteries and nickel metal hydride rechargeable batteries. Such high discharge voltages are a major feature of lithium ion rechargeable batteries. For instance, when driving equipment with an operating voltage range of 3 V to 4 V, if using nickel cadmium rechargeable batteries, three cells must be used connected in series, whereas a single lithium ion rechargeable battery is sufficient to drive the same equipment. In addition, by measuring the discharge voltage of lithium ion rechargeable batteries combined hard carbon as the anode carbon material and lithium ion rechargeable batteries using nickel cathode material with graphite anodes, the remaining capacity can be easily determined.

2-3 Storage characteristics

2-3

2-3-1 Self-discharge characteristics

2-3-1

Self-discharge is affected by the storage temperature and by the depth of charge. The nearer the battery is to the fully-charged state at the time of storage, and the higher the ambient temperature, the greater will be the decrease in capacity. When a fully-charged lithium ion rechargeable battery is stored, it ordinarily loses about 10% of its capacity in three months; however, this is a small amount compared with the self-discharge in rechargeable batteries with alkaline solution such as nickel cadmium and nickel metal hydride batteries.

2-3-2 Long-term storage characteristics

2-3-2

When batteries are stored over a long period, depending on the battery state and the storage temperature, in some cases irreversible deterioration may occur and the battery will fail to hold a charge even after recharging. Deterioration is not observed in batteries in the discharged state, but the greater the charge in the battery, the more pronounced the deterioration after storage. Also, the higher the storage temperature, the greater the deterioration tends to be. For these reasons, lithium ion rechargeable batteries should be in the discharged state when stored for extended lengths of time, and it is desirable that they be stored in a low-temperature environment.

2-4 Charge/discharge cycle characteristics

2-4

As charge/discharge cycles are repeated, the battery capacity (ability to hold a charge) gradually declines. However, when batteries are charged and discharged under the conditions recommended by Sony, they can be used for 500 or more charge/discharge cycles.

The maximum voltage for charging is 4.2 V, and the cutoff voltage in discharge is 2.5 V (for hard carbon batteries) and 3.0 V (for graphite batteries with cobalt oxide cathode). If batteries are charged or discharged at voltages outside these ranges, battery performance and safety are compromised. Lithium ion rechargeable batteries are not subject to the so-called memory effect seen in alkaline aqueous-solution rechargeable batteries, in which the discharge voltage is reduced when repeated shallow charge/discharge cycles are followed by a deep discharge.

2-5-1 Polymer (UP383562)

Lithium ion rechargeable batteries with lithium cobalt oxide cathode and graphite anodes

1. Charge characteristics

1-[1] Charge characteristics

Figure 3 shows the charging voltage, charging current, and charging capacity when charging under constant-voltage, constant-current conditions (maximum charging voltage 4.2V, maximum charging current 720mA, ambient temperature 23).

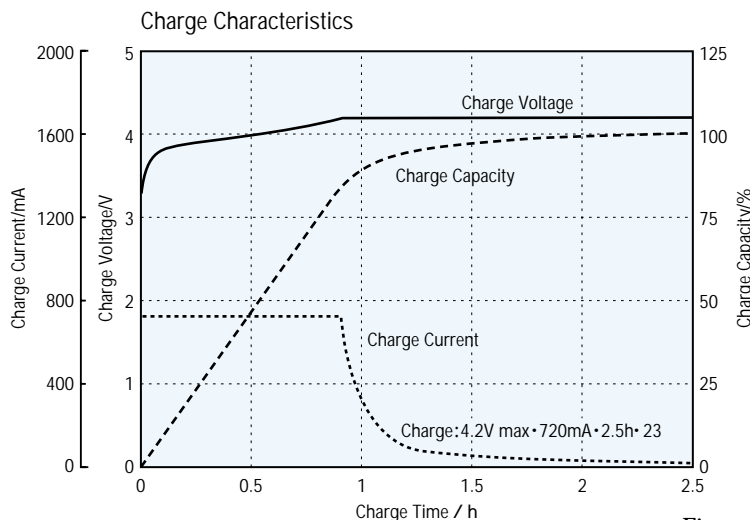

Figure 3

1-[2] Charging current characteristics

(charging current dependence of charging capacity)

Figure 4 shows the change in battery charge with constant-voltage, constant-current charging at charging currents of 145mA, 360mA, 720mA and 1440mA.

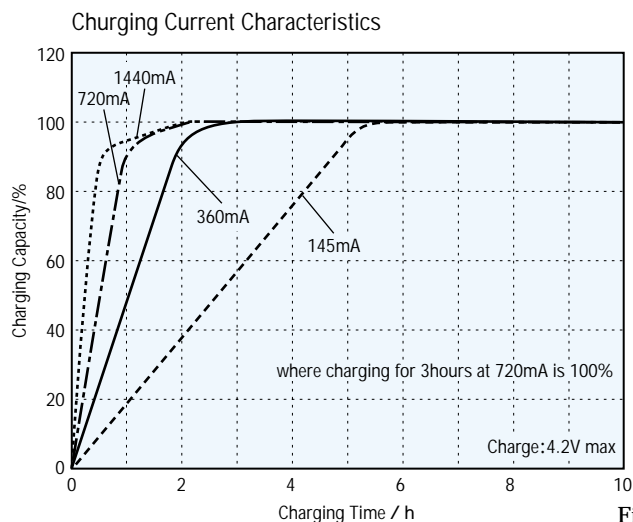

Figure 4

1-[3] Charge temperature characteristics

(ambient temperature dependence of discharge capacity)

Figure 5 shows the change in discharge capacity upon constant-voltage, constant-current charging at ambient temperatures between 0 and 45 .

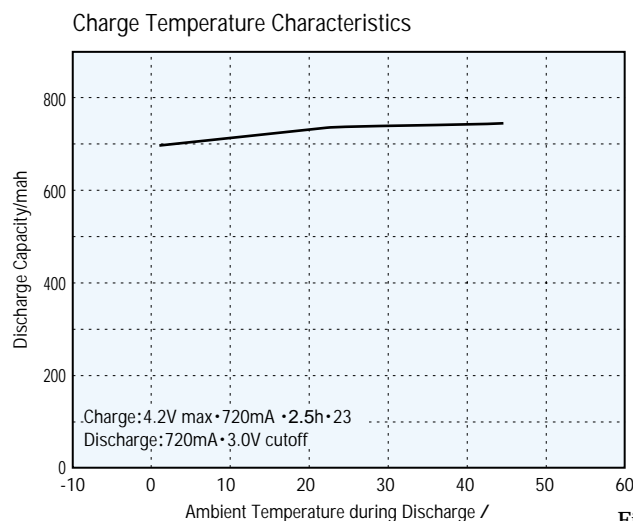

Figure 5

2. Discharge characteristics

2-[1] Discharge characteristics on load

Figure 6 shows changes in the battery voltage for constant-current discharge at an ambient temperature of 23 °C, with the discharge current at 145mA, 360mA, 720mA and 1440mA.

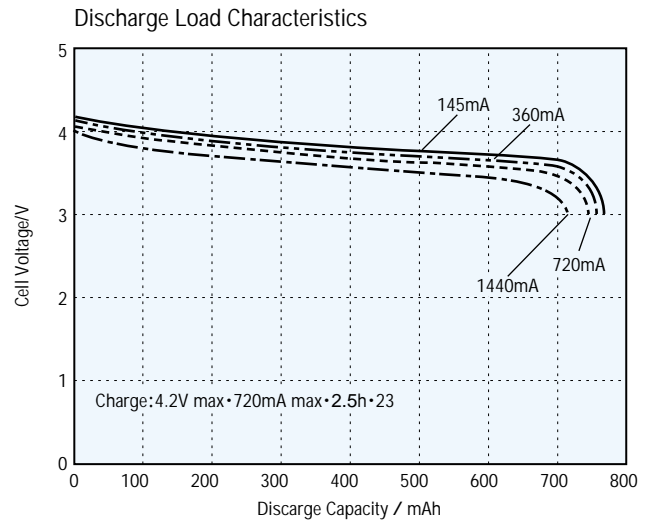

Figure 6

2-[2] Discharge characteristics on temperature

Figure 7 shows changes in the discharge voltage for constant-current discharge at a discharge current of 360mA, at ambient temperatures of -20 °C, -10 °C, 0 °C, 23 °C and 45 °C.

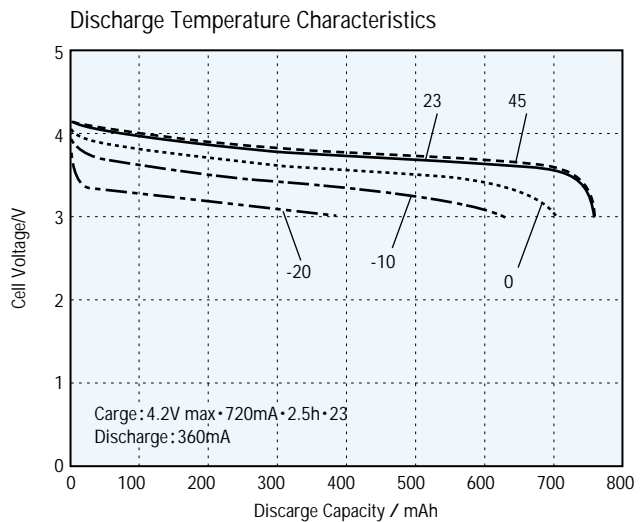

Figure 7

3. Storage characteristics

3-[1] Self-discharge characteristics

Figure 8 shows the change in discharge capacity retention for batteries stored at ambient temperatures of 23 °C and 45 °C, where the capacity retention of the fully-charged battery prior to storage is 100%.

3-[2] Long-term storage characteristics(1)

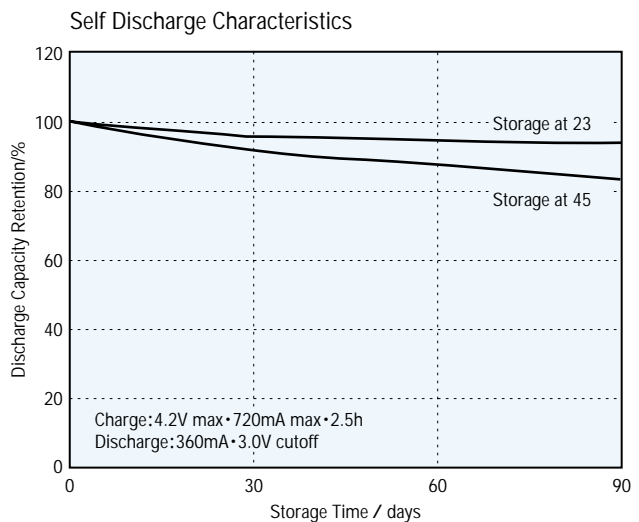

Figure 8

3-[2] Self-discharge characteristics (1)

Figure 9 shows the battery capacity retention after long-term storage at a storage temperature of 23 °C, with the battery initially in the fully-charged state, 50% charged state, and discharged state.

The capacity in the fully-charged state prior to storage is taken to be 100%, and the discharge capacity after storage is determined by first discharging the battery to the cutoff voltage, then fully recharging at 4.2 V and 720mA, and measuring the discharge capacity of the battery in constant-current discharge to a cutoff voltage of 3.0 V at 360mA.

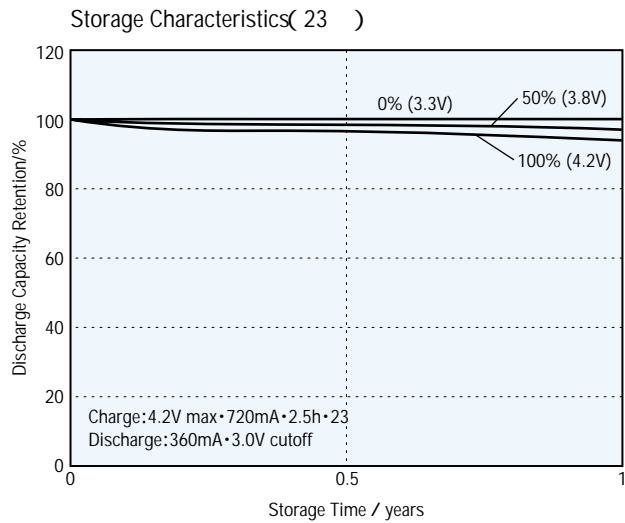

Figure 9

3-[3] Long-term storage characteristics (2)

Figure 10 shows the battery capacity retention after long-term storage at a storage temperature of 45 °C, with the battery initially in the fully-charged state, 50% charged state, and discharged state.

The capacity in the fully-charged state prior to storage is taken to be 100%, and the discharge capacity after storage is determined by first discharging the battery to the cutoff voltage, then fully recharging at 4.2V, and measuring the discharge capacity of the battery in constant-current discharge to a cutoff voltage of 3.0V at 360mA.

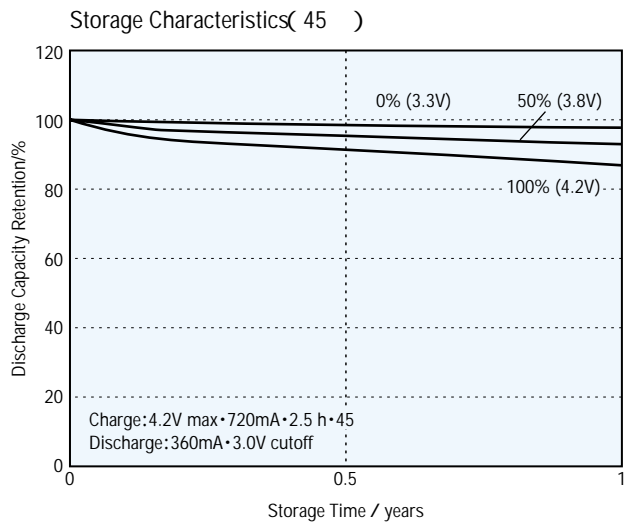

Figure 10

3-[4] Cycle life characteristics

Figure 11 shows the charge/discharge cycle life characteristics when a battery is fully charged under constant voltage and current, and then discharged under a constant current of 360mA to a cutoff voltage of 3.0V.

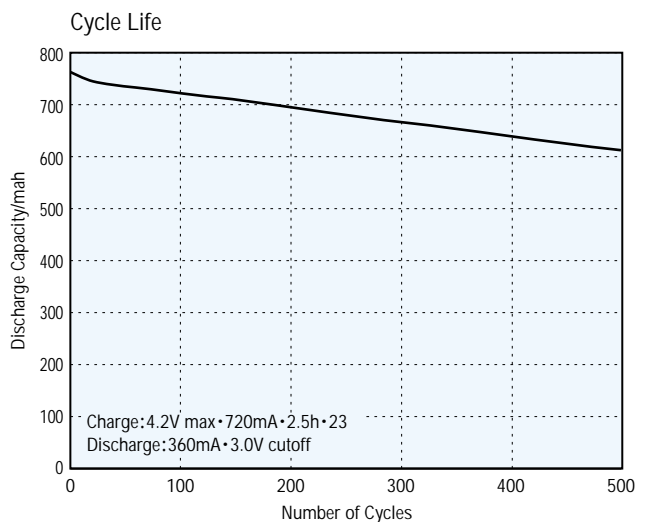

Figure 11

4 GSM Pulse mode

4-[1] Discharge characteristics at GSM pulse mode

Discharge characteristics at pulse system which is used in Global System for Mobile Communications* is shown.

*Recently this system is used in 159 all over the world including Europe, and becomes main format of cellular phones.

Definitely, it is a discharge method using approx. 1.7A 0.6 msec at high voltage pulse and approx. 0.1A 4.0 msec as side of low voltage pulse. (These voltage value and pulse ratio are different between each GSM cellular manufacturer.)

This discharge characteristics should be measured by high density and special discharge equipment in order that these two voltage value 0.6 msec and 4.0 msec are acted and used.

Sony's polymer cell was successful in decrease inner resistance. And GSM discharge characteristics which voltage drop is few and stable at low and high voltage value is shown (refer to Figure 12).

DC inner resistance measured by this GSM pulse is low like as approx. 60 m and there is no increase by discharge.

4-[2] Discharge characteristics on temperature at GSM pulse mode

Characteristics which discharge temperature is changed with the same conditions as 4-[1].

Polymer cells also succeed to wide temperature movement of lithium ion feature and keep high reliability.

It is possible to take out 550 mAh capacity under the environmental -10 which has high possibility to practical use.

It corresponds to about 75% of the normal temperature. Further, discharge is possible at -20 (refer to Figure 13).

Recently, polymer batteries shipped to Europe obtains high estimation in practical use.

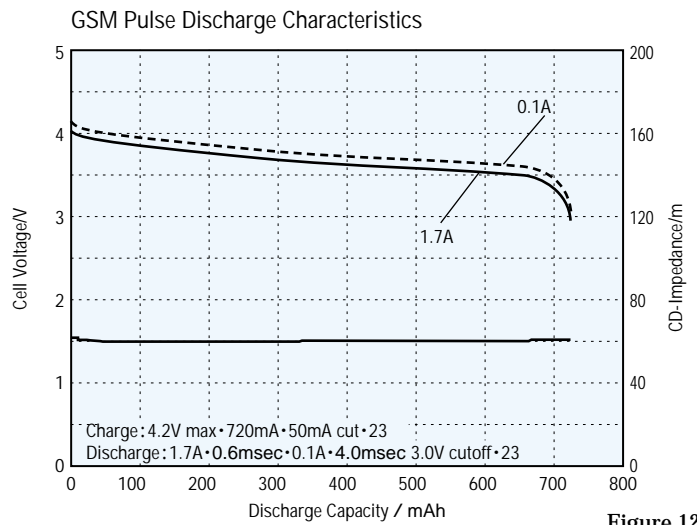

Figure 12

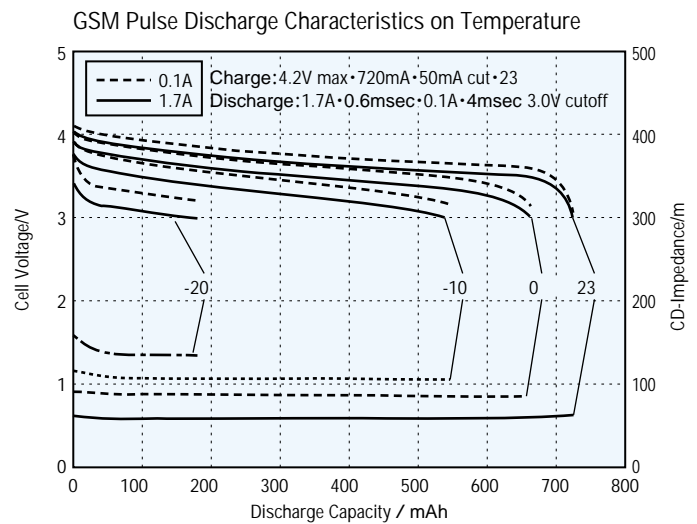

Figure 13

Lithium ion rechargeable batteries with lithium cobalt oxide cathodes and graphite anodes

1. Charge characteristics

1-[1] Charge characteristics

Figure 14 shows the charging voltage, charging current, and charging capacity when charging under constant-voltage, constant-current conditions (maximum charging voltage 4.2V, maximum charging current 1000mA, ambient temperature 23).

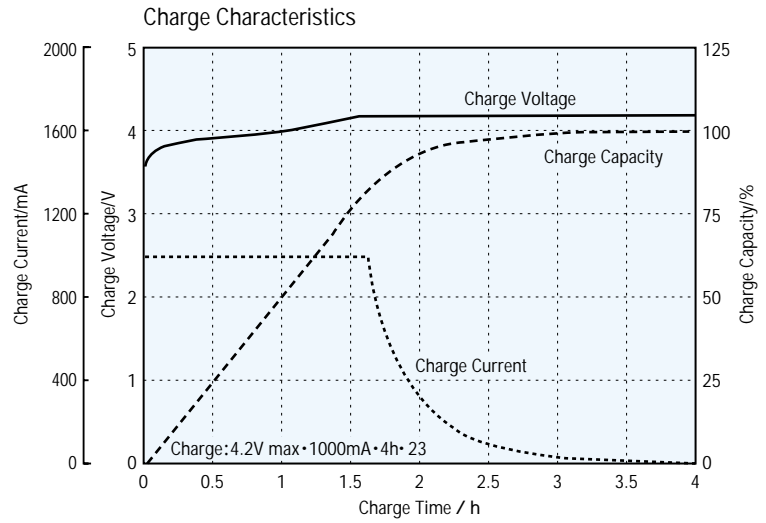

Figure 14

1-[2] Charging current characteristics

(charging current dependence of charging capacity)

Figure 15 shows the change in battery charge with constant-voltage, constant-current charging at charging currents of 400mA, 1000mA and 2000mA.

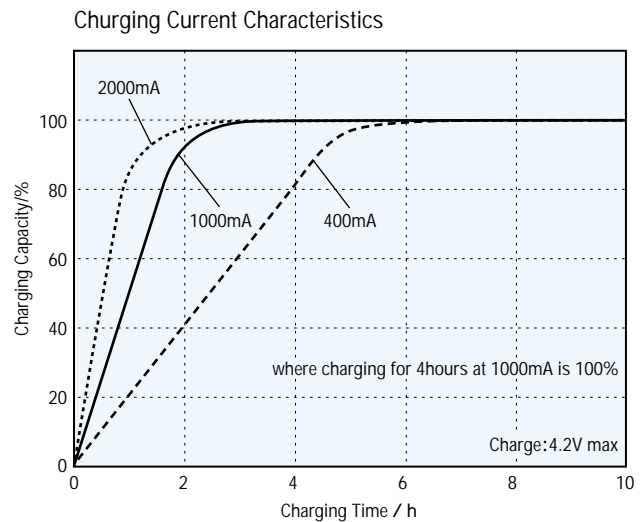

Figure 15

1-[3] Charge temperature characteristics

(ambient temperature dependence of discharge capacity)

Figure 16 shows the change in discharge capacity upon constant-voltage, constant-current charging at ambient temperatures between 0 and 45 .

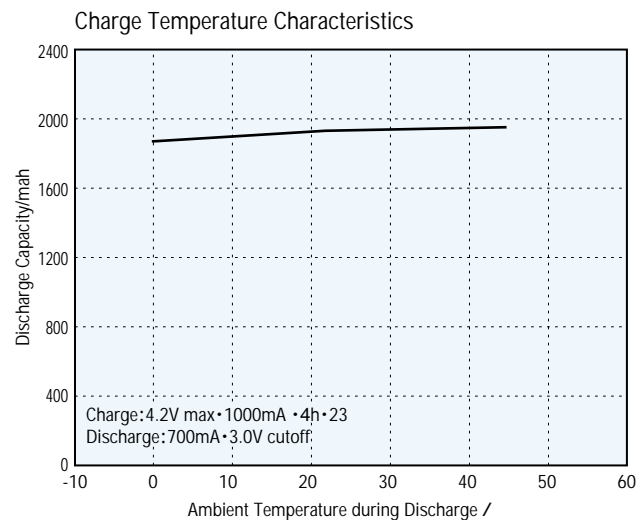

Figure 16

2. Discharge characteristics

2-[1] Discharge characteristics on load

Figure 17 shows the change in the battery voltage for constant-current discharge at ambient temperature of 23 °C, with the discharge current at 400mA, 700mA, 1000mA, 2000mA, 4000mA.

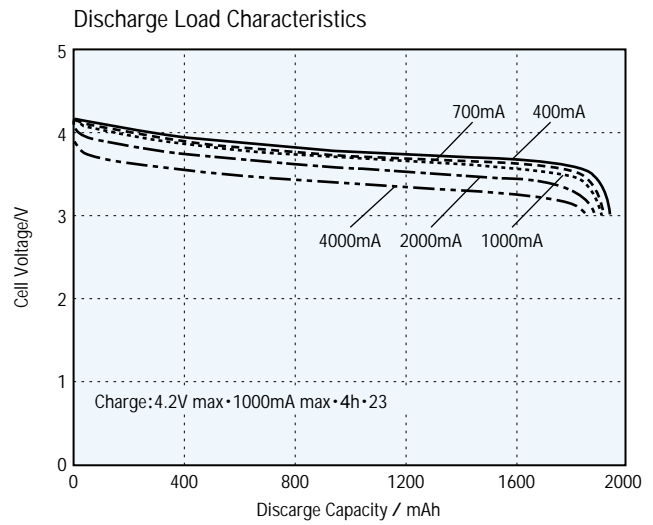

Figure 17

2-[2] Discharge characteristics on temperature

Figure 18 shows changes in the discharge voltage for constant-current discharge at discharge current of 700 mA, at ambient temperatures of -20 °C, -10 °C, 0 °C, 23 °C and 45 °C.

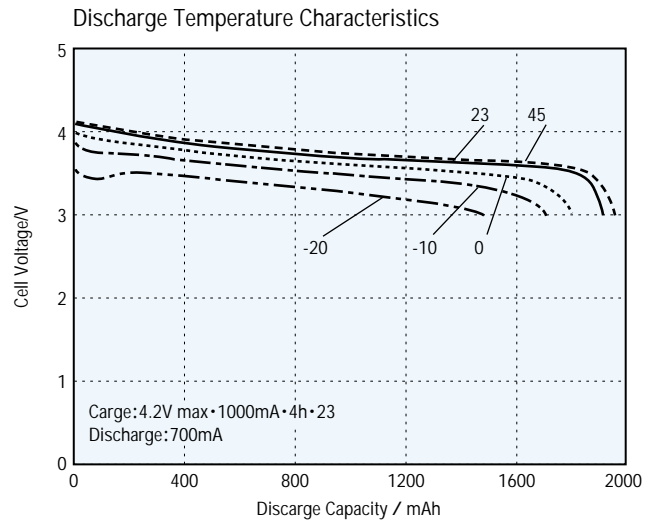

Figure 18

3. Storage characteristics

3-[1] Self-discharge characteristics

Figure 19 shows the change in discharge capacity retention for batteries stored at ambient temperatures of 23 °C, and 45 °C, where the capacity retention of the fully-charged battery prior to storage is 100%.

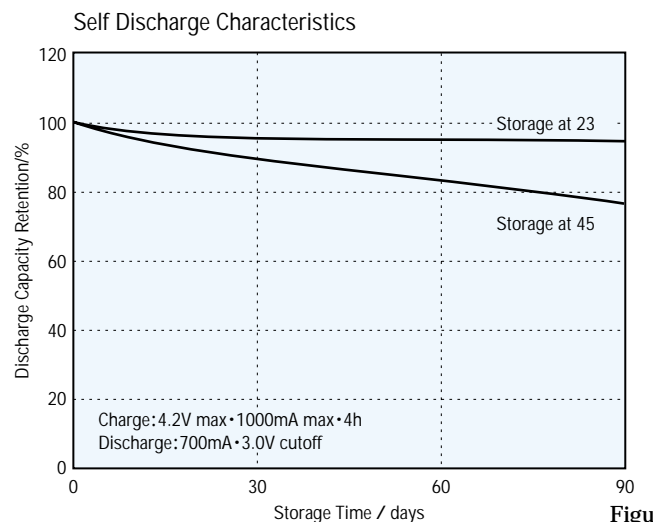

Figure 19

3-[2] Long-term storage characteristics (1)

Figure 20 shows the battery capacity retention after long-term storage at a storage temperature of 23 °C, with the battery initially in the fully-charged state, 50% charged state, and discharged state.

The capacity in the fully-charged state prior to storage is taken to be 100%, and the discharge capacity after storage is determined by first discharging the battery to the cutoff voltage, then fully recharging at 4.2V and 700 mA, and measuring the discharge capacity of the battery in constant-current discharge to a cutoff voltage of 3.0 V at 700mA.

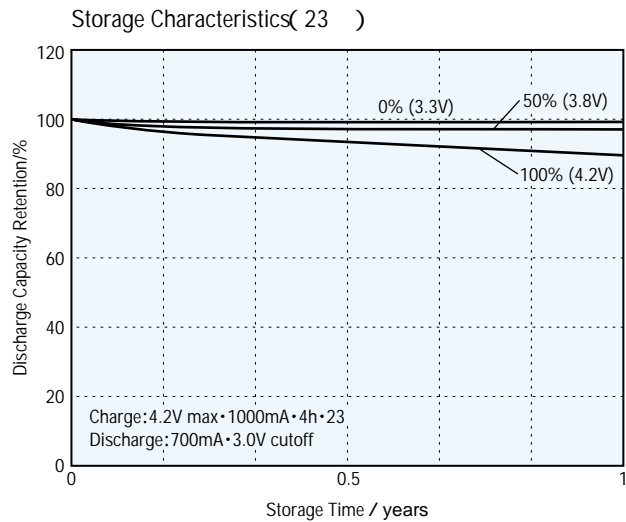

Figure 20

3-[3] Long-term storage characteristics (2)

Figure 21 shows the battery capacity retention after long-term storage at a storage temperature of 45 °C, with the battery initially in the fully-charged state, 50% charged state, and discharged state.

The capacity in the fully-charged state prior to storage is taken to be 100%, and the discharge capacity after storage is determined by first discharging the battery to the cutoff voltage, then fully recharging at 4.2V, and measuring the discharge capacity of the battery in constant-current discharge to a cutoff voltage of 3.0V at 700mA.

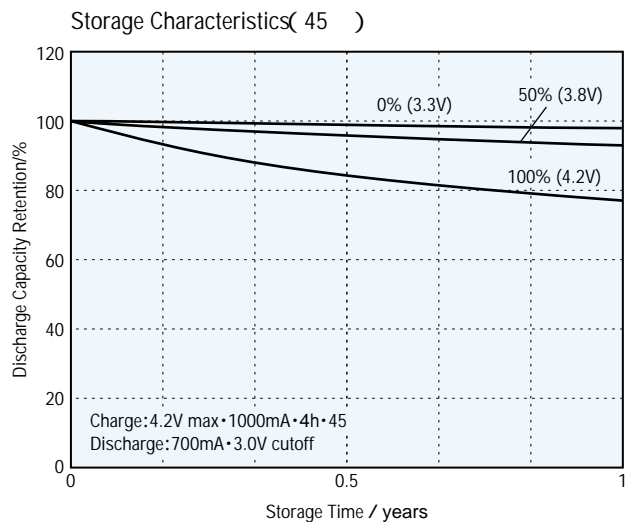

Figure 21

3-[4] Cycle life characteristics

Figure 22 shows the charge/discharge cycle life characteristics when a battery is fully charged under constant voltage and current, and then discharged under a constant current of 700mA to a cutoff voltage of 3.0V.

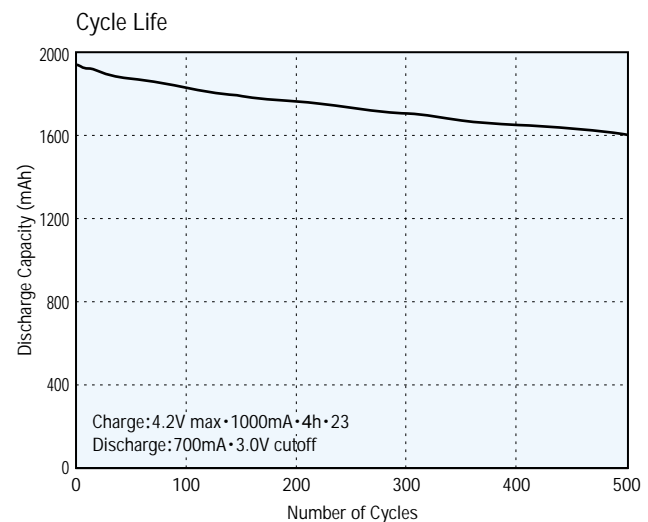

Figure 22

2-5-3 Hard carbon (US18650)

Lithium ion rechargeable batteries with lithium cobalt oxide cathodes and hard carbon anodes

1. Charge characteristics

1-[1] Charge characteristics

Figure 23 shows the charging voltage, charging current, and battery charge under constant-voltage, constant-current conditions (maximum charging voltage 4.2V, maximum charging current 1000mA, ambient temperature 23).

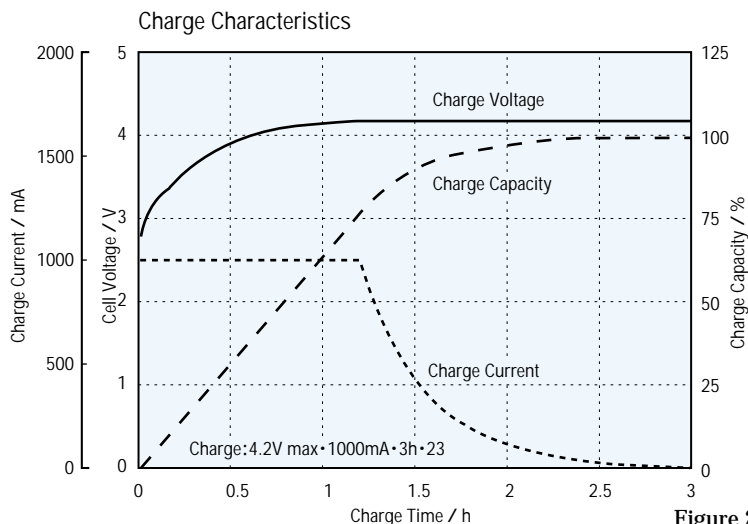

Figure 23

1-[2] Charging current characteristics

(charging current dependence of charging capacity)

Figure 24 shows the change in battery charge with constant-voltage, constant-current charging at charging currents of 200mA, 500mA, 1000mA and 2000mA.

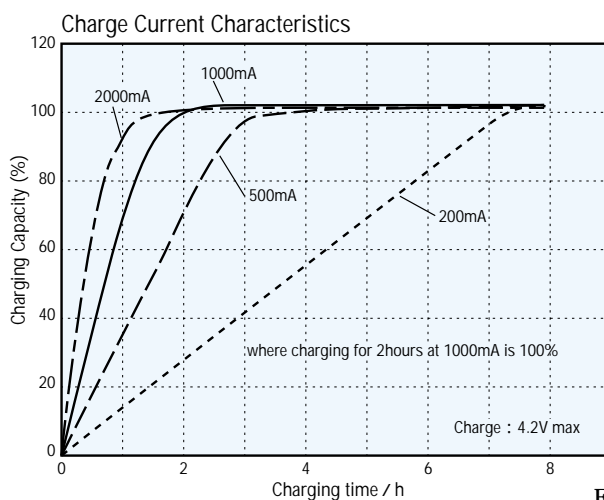

Figure 24

1-[3] Charge temperature characteristics

(ambient temperature dependence of battery chargedischarge capacity)

Figure 25 shows the change in discharge capacity upon constant-voltage, constant-current charging at ambient temperatures between 0 and 45 .

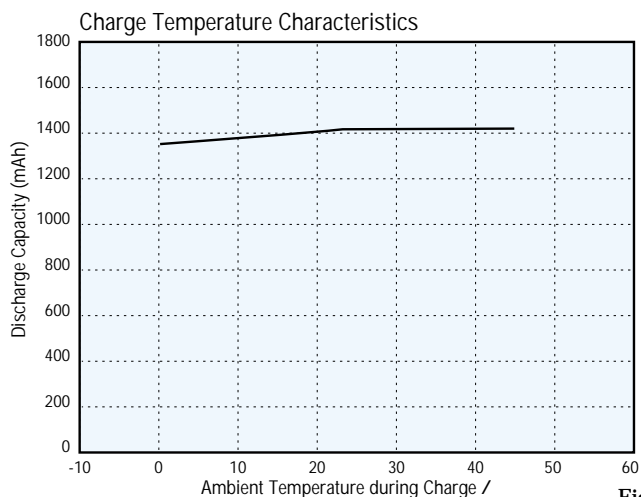

Figure 25

2. Discharge characteristics

2-[1] Discharge characteristics on load (1)

Figure 26 shows changes in discharge curves for constant-current discharge at an ambient temperature of 23 °C, with the discharge current at 280mA, 700mA, 1400mA, and 2800mA.

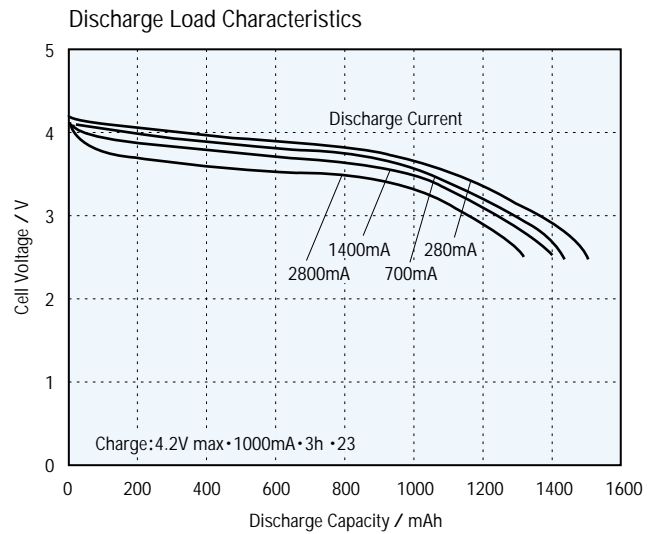

Figure 26

2-[2] Discharge characteristics on temperature

Figure 27 shows changes in the discharge voltage for constant-current discharge at a discharge current of 750 mA, at ambient temperatures of -20 °C, -10 °C, 0 °C, 23 °C and 45 °C.

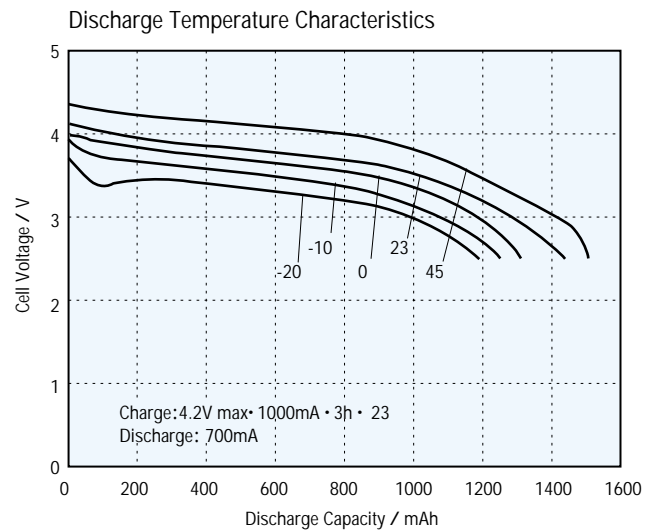

Figure 27

3. Storage characteristics

3-[1] Self-discharge characteristics

Figure 28 shows the change in discharge capacity retention for batteries stored at ambient temperatures of 23 °C, 30 °C and 45 °C, where the capacity retention of the fully-charged battery prior to storage is 100%.

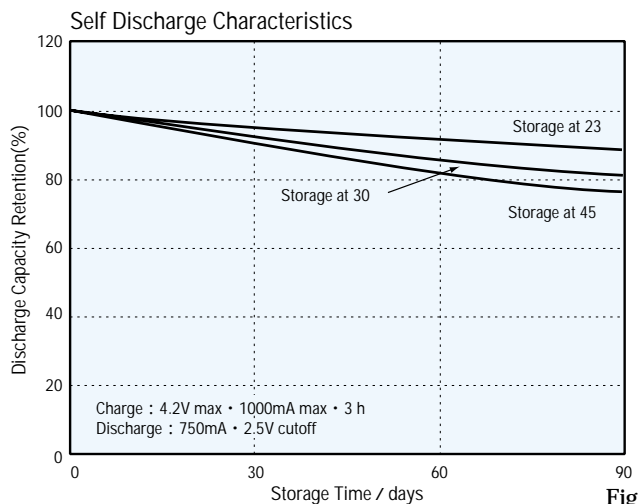

Figure 28

3-[2] Long-term storage characteristics (1)

Figure 29 shows the battery capacity retention after long-term storage at a storage temperature of 20 °C, with the battery initially in the fully-charged state, 50% charged state, and discharged state.

The capacity in the fully-charged state prior to storage is taken to be 100%, and the discharge capacity after storage is determined by first discharging the battery to the cutoff voltage, then fully recharging at 4.2V, and measuring the discharge capacity of the battery in constant-current discharge to a cutoff voltage of 2.75V at 750mA.

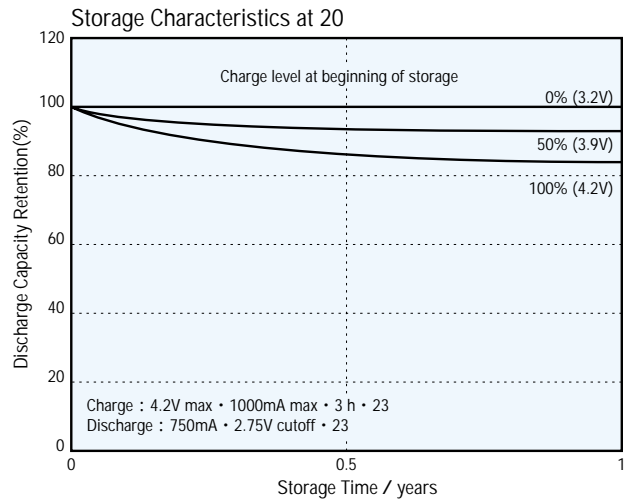

Figure 29

3-[3] Long-term storage characteristics (2)

Figure 30 shows the battery capacity retention after long-term storage at a storage temperature of 40 °C, with the battery initially in the fully-charged state, 50% charged state, and discharged state.

The capacity in the fully-charged state prior to storage is taken to be 100%, and the discharge capacity after storage is determined by first discharging the battery to the cutoff voltage, then fully recharging at 4.2V, and measuring the discharge capacity of the battery in constant-current discharge to a cutoff voltage of 2.75V at 750mA.

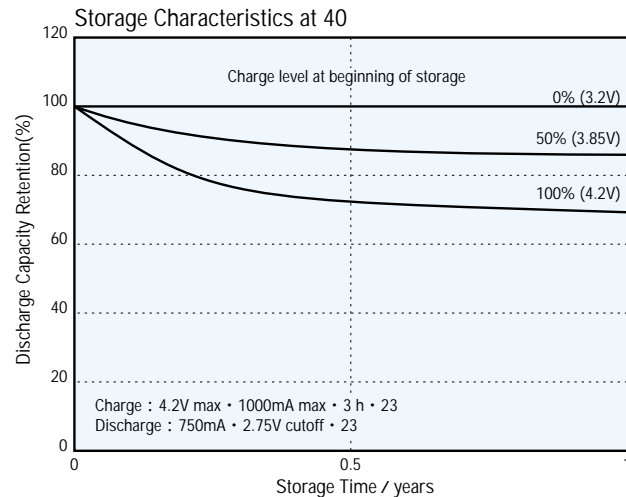

Figure 30

3-[4] Cycle life characteristics

Figure 31 shows the charge/discharge cycle life characteristics when a battery is fully charged under constant voltage and current, and then discharged under a constant current of 750mA to a cutoff voltage of 2.5V.

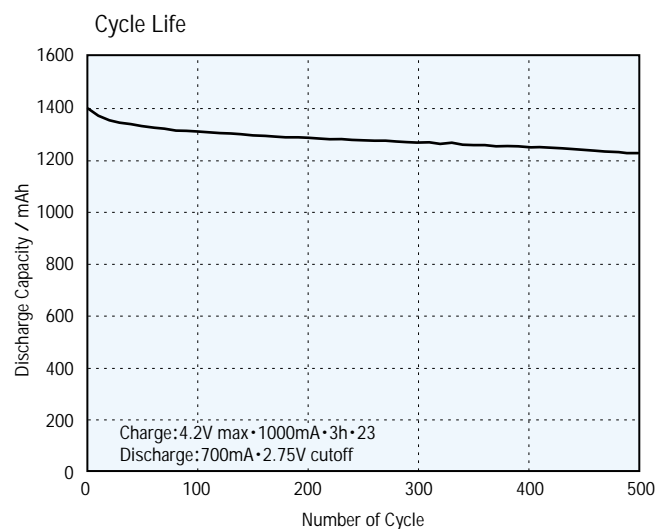

Figure 31

3 Safety

3-1 General safety

3-1

Lithium ion batteries inherit the excellent energy density and terminal voltage of lithium batteries, but in contrast with their lithium battery forebears, they also feature a high level of safety. This is because, as their name indicates, over normal operating ranges the lithium inside lithium ion rechargeable batteries is always in the ionic state, rather than in a metallic or alloy state. Since no metallic lithium or lithium alloys whatsoever are used, United Nations recommendations for transport of hazardous materials also regard lithium ion rechargeable batteries as safer than metallic lithium rechargeable batteries. And, lithium ion rechargeable batteries have been confirmed to meet high safety standards in dozens of rigorous tests, regardless of the state of battery charging. They have also been certified by Underwriters Laboratories, a well-respected organization which evaluates the safety of electrical equipment, as conforming to standards UL-1642 File No.MH12566.

As for the polymer cell, special gel polymer electrolyte is used instead of the electrolyte which is used to the lithium ion cell normally. Therefore there is no leak of the electrolyte within the cell for general use.

3-2 Safety mechanisms

3-2

For example, cylindrical batteries are incorporated such safety mechanisms as circuit-breaker devices, safety vents, and PTC devices. The maximum charging voltage of the dedicated recharger for these batteries is set to 4.2 V, but should the recharger malfunction and the maximum setting become invalid, the Li_2CO_3 added to the cathode would dissociate from around 5 V, and the gas generated as a result would cause an increase in the internal battery pressure. This change in pressure would cause the safety vent to be deformed, removing the cathode lead and cutting off the charging current, thereby ensuring safety. In addition, should the battery be exposed to a fire or some other extreme temperature condition causing a sudden increase in internal pressure, the safety vent would split, averting possible danger. Moreover, should erroneous use result in the flow of large currents and battery charging and discharging, the PTC device will act to reduce the current.

3-3 Procedures to confirm safety and results

3-3

As explained in the preceding section, various measures relating to safety have been implemented.

Below are test results for safety and abuse in conformation with JIS C 8711 Secondary Lithium Cells for Portable Applications.

3-3-1 Safety Tests

3-3-1

Test Item	Battery State	Temperature	Test Method	Test Results
Continuous charging test	Fully charged	20 ± 5	The battery is charged at a constant current to 1CmA to a terminal voltage of 4.2 V under constant-voltage, constant-current conditions, and after the terminal voltage has reached 4.2V the battery is continuously charged for 28 days at constant voltage.	No leakage, safety valve operates, rupture or ignition
Shock test Same unit battery is used	Fully charged	20 ± 5	Shocks with minimum average acceleration during the initial 3 ms between 75 G and peak acceleration between 125 G and 175 G are applied orthogonally in XYZ directions.	No leakage, safety valve operates, rupture or ignition
↓				
Vibrations test	Fully charged	20 ± 5	Vibrations of amplitude 0.8 mm, with frequency varied between 10 and 55 Hz, swept at 1 Hz/min are applied for 90 min orthogonally in XYZ directions.	No leakage, safety valve operates, rupture or ignition
↓				
Free-fall test	Fully charged	20 ± 5	The battery is dropped twice from a height of 1 m onto each side of a hard tree board.	No rupture or ignition
High-temperature maintenance test Same unit battery is used	Fully charged	-	The battery is kept for 48 hours at 75 ± 2 °C.	No leakage, safety valve operates, rupture or ignition
↓				
Thermal shock test	Fully charged	-	After the battery is kept for 48 hours at 75 ± 2 °C, kept for 6 hours at -20 ± 2 °C within 5 minutes. Then kept 24 hours at -20 ± 5 °C.	No leakage, safety valve operates, rupture or ignition
↓				
Low-pressure test	Fully charged	20 ± 5	The battery is left for 6 hours in an environment with an atmospheric pressure of 11.6kPa.	No leakage, safety valve operates, rupture or ignition

3-3-2 Abuse Tests

3-3-2

Test Item	Battery State	Temperature	Test Method	Test Results
Short-circuit test	Fully charged	20 ± 5	The battery terminals are terminated until voltage is 0.1 V or less with a resistance of 50 m Ω or less.	No rupture or ignition; 150 or less of battery temperature 55 ± 2 °C.
Forced discharge test	Fully charged	20 ± 5	The battery is discharged for 12.5 hours with 0.2 It[A] of constant current.	No rupture or ignition
Over-charging test	Fully charged	20 ± 5	The battery is charged at 1.0It[A] current to 250% of its rated capacity with a power supply of 10V or more.	No rupture or ignition
High-rate charge test	Fully charged	20 ± 5	The battery is charged to 100% to its rated capacity under constant-voltage, constant-current conditions, with an upper voltage limit of 10V or more.	No rupture or ignition
Crushing test	Fully charged	20 ± 5	The battery is placed between two parallel flat steel plates, such that the electrodes are parallel to the plates, a force of 13 kN is applied.	No rupture or ignition
Impact test	Fully charged	20 ± 5	A round rod 8 mm in diameter is placed near the center of the battery, parallel to the electrodes and perpendicular to the direction of the upper terminal of the battery, and a 9 kg weight is dropped from a height of 60 cm onto the rod.	No rupture or ignition
Heat exposure test	Fully charged	20 ± 5	The battery is placed in an oven and heated to 130 ± 2 °C at a rate of 5 ± 2 °C/min; the temperature is then maintained at 130 ± 2 °C for 60 min.	No rupture or ignition

The electrolyte is a nearly-transparent fluid with a slight aroma. It is a solution consisting of a mixture of solvents including carbonate esters, in which is dissolved lithium phosphate hexafluoride.

The Poisonous and Deleterious Substances Control Laws do not apply to this electrolyte.

The electrolyte has been designated a Second Class Petroleum, Type 4 (flammable liquid) as provided by the Japanese Fire Service Law.

Disassembly and physical deformation of the battery pack by an external force are forbidden, consequently there is no leakage of the electrolyte within the cell; nor does any leakage of electrolyte occur in ordinary battery use. However, in the unlikely event that electrolyte should leak and come into contact with the skin, the affected area will gradually become painful, and if left untreated burns could result. In such cases it is recommended that the following emergency treatment be provided.

1. Should electrolyte come in contact with the skin:

Immediately wash away all the electrolyte with clean water (such as tap water).

2. Should electrolyte come in contact with the eyes:

Immediately flush the eyes with clean water (such as tap water) for 15 minutes or longer, and seek the attention of an eye doctor immediately.

3. In other cases:

If the electrolyte has been swallowed, have the victim drink large quantities of slightly warm water (or milk) to induce vomiting, and seek immediately medical attention.

If a rag or other material containing electrolyte is burned, there is a tendency for irritating gases to be released. Clean all such materials thoroughly with running water before disposal.

4 Battery Modules

4-1 Battery modules

4-1

From safety considerations, lithium ion rechargeable batteries are never used in bare cell units, but are always used with a protective circuit. Moreover, normally multiple cells are combined in a single housing and used as a battery pack or module. The configuration of cells in a battery pack is determined with consideration paid to the following matters.

- (1) The total number of cells is determined from the capacity per cell, the load to be driven, and the number of hours of operation required.
- (2) The maximum discharge current for cells is stipulated; this maximum current, and the maximum load to be driven, are used to determine the number of cells to be connected in parallel.
- (3) The number of cells to be connected in series is determined referring to the upper and lower limits to the operating voltage.

Many of the requirements arising from (1), (2) and (3) above conflict with limits placed on battery size (or shape) and weight. Some compromise between conflicting requirements must be found.

Due to the ratings of devices used in protective circuitry, at present no more than four cells may be connected in series.

In considering cell configurations, the efficiency of battery use is highly important. Batteries have an internal resistance, and when used at large currents losses can be considerable. Hence lower battery currents are desirable to improve efficiency.

It is also important that the load current pattern be considered. There are cases in which the average current is relatively low but there are large pulse currents (cellular phones are one example of such a load), and also cases in which the ratio of the peak current to the average current is relatively small (as in notebook computers).

4-2 Protective circuitry within battery packs

(Fig. 32: Block diagram of batteries for PCs)

4-2

Various mechanisms are incorporated into the lithium ion rechargeable battery cells themselves to ensure safety. Depending on the battery pack configuration and charge/discharge conditions, certain safety components may be omitted.

(fig.39) Peripheral circuitry (voltage output, current output, microprocessor power supply, overcharge/overdischarge current detection, FET switch drivers)

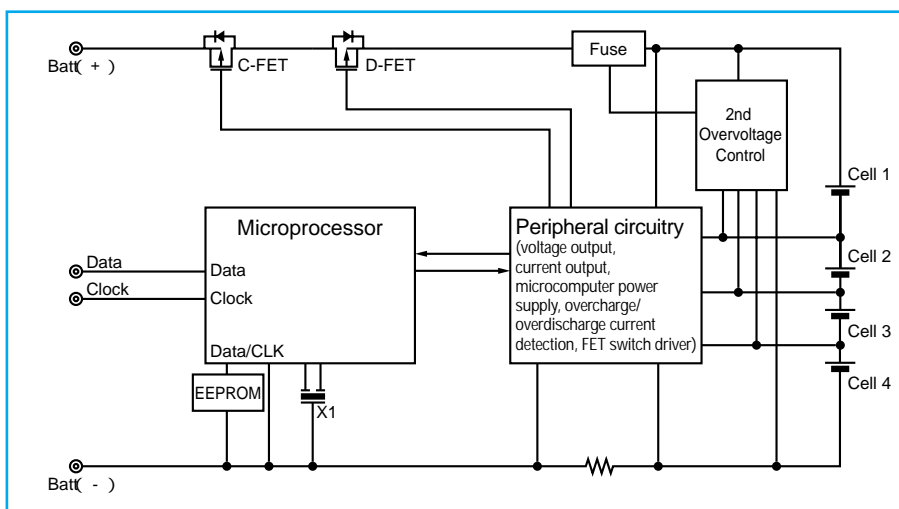

Figure32

4-2-1 Charge voltage regulation

4-2-1

As the charging proceeds, lithium ions are removed from the cathode and the cell voltage (electromotive force) gradually rises; but if the quantity of lithium ions reaching the anode exceeds the capacity of the anode to accommodate them, metallic lithium is deposited on the anode surface. If the amount of precipitated metallic lithium increases, precipitated metallic lithium grows like branches. It could penetrate the separator and reach the cathode, resulting in an internal short-circuit. Moreover, overcharging renders the safety of the cathode active material and electrolyte down, and induces rapid degradation of the cell capacity, making the cell unusable. In order to avoid these consequences, a reference voltage is established and charging is controlled to keep this reference voltage from being exceeded and prevent overcharging. The protective circuit monitors the voltage of each cell, and should the cell voltage rise above a preset value the C-FET (FET used for charge regulation) is turned off, terminating the charging.

4-2-2 Overdischarge voltage regulation

4-2-2

Circuits monitor the voltage of each cell. When the cell terminal voltage falls below a preset value, the D-FET (discharge regulator FET) is turned off, terminating discharge. This control is necessary because if the voltage falls below the preset value, the copper foil as the anode current collector material at the anode begins to be dissolved, and during charging this copper is precipitated on the cathode surface and causes an internal short-circuit.

4-2-3 Overcurrent regulation

4-2-3

If the battery terminals are short-circuited, a large current flows, destroying the battery. To prevent this, when a current exceeding a preset value flows, a FET is turned off.

4-2-4 Temperature regulation

4-2-4

If a cell is overcharged above a certain temperature, reaction of active material with the electrolyte may cause an abnormal exothermic reaction within the cell. To prevent this, battery packs are provided with a thermistor which prevents charging and discharging if the cell temperature is above a certain value.

4-2-5 Redundant-protection circuitry

4-2-5

Overcharging must be avoided more than any other mishap. To this end, in addition to the main circuitry for charge/discharge control, redundant-protection circuitry to detect overcharging is also provided. When this circuit detects overcharging, it causes a fuse within the battery to blow, so that the battery can never be used again.

4-2-6 Chain short protection

4-2-6

Because battery packs (particularly those intended for use with cellular phones, camcorders and similar equipment) are compact and lightweight, they will frequently be carried within purses, handbags and the like. While being so carried, the metal parts of necklaces or other items may come into contact with both the positive and negative battery terminals, creating a conductive path between them and causing the necklace or other item to heat and perhaps melt. ("Chain shorts" are different from ordinary short-circuits in that the contact resistance or other resistance limits the current to several amps or so, so that often it is difficult to distinguish such short-circuits from ordinary discharge currents.) For this reason, battery packs may be provided with a mechanism and circuit such that battery discharge is only possible when the battery pack is mounted in the equipment for which it is intended.

In special cases, or at customer request, battery packs may also incorporate PTCs (positive-characteristic thermistors) device or thermostats.

4-3 Operation of battery packs for PCs

4-3-1 Operating range of batteries for power supply systems

Cell operating voltages are from 2.5 V (3.0V for graphite batteries) (remaining charge 0%) up to 4.2 V (remaining charge 100%). When the voltage falls below 2.5 V, discharge to the equipment is terminated. In addition, the consumption current of the internal circuitry is also minimized (power-down).

When the voltage rises above 4.2 V, charging is stopped to ensure safety.

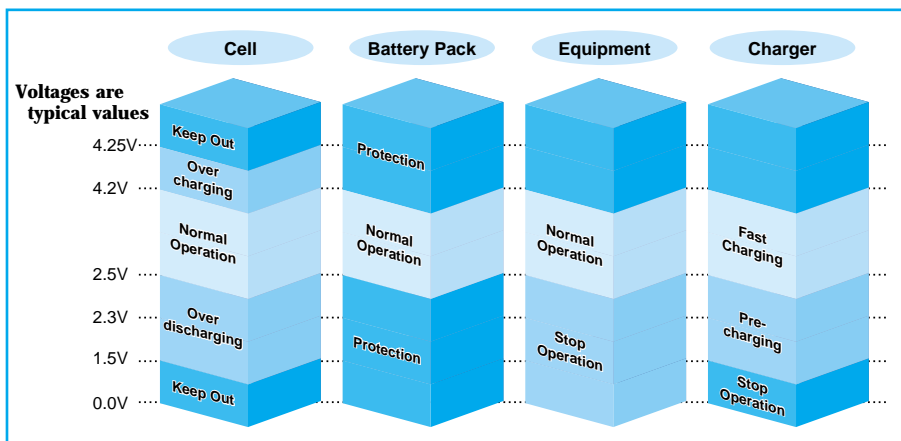

Figure 33

Circuitry within the battery is operated using the battery's own power. Hence the consumption current of the circuitry must be kept as small as possible. When a notebook computer is not being operated on battery power, the battery is put into sleep mode to minimize current consumption (microprocessor operation is stopped).

When overcurrents and high temperatures are detected, or when overcharging is detected, a FET acting as a switch is turned off, or a fuse is blown.

5 Charging Procedure

5-1 Recharger voltage per cell: 4.20 ± 0.05 V

5-1

Battery charging and discharging occurs through the migration of lithium ions between cathode and anode. The quantity of lithium ions dedoped from the cathode during charging determines the cathode potential. On the other hand, because there is a limit to the quantity of lithium ions with which the carbon material of the anode can be doped, it is important that the voltage be limited during charging, to prevent overcharging. For this reason, as a rule lithium ion secondary rechargeable batteries are charged using a recharger which regulates the maximum charging voltage, and the maximum charging voltage per cell is set at $4.2V \pm 0.05V$.

When the charging voltage shifts to high voltage side, battery degradation occurs early, and safety goes down. When the charging voltage shifts to low voltage side, battery charge level is decreased. Please design the power supply of the recharger such that the charging voltage falls within this $\pm 0.05V$ tolerance, taking into consideration the charging temperature range (0 to 40), aging, and other relevant parameters.

*Charging voltages for multiple cells in series:

1S	4.20 ± 0.05 V
2S	8.40 ± 0.10 V
3S	12.60 ± 0.15 V
4S	16.80 ± 0.20 V

5-2 Charge time

5-2

Standard charge time for charging cells to their rated capacity is 2.5 hours at a charging voltage of 4.20 V/cell and charging current of 1C. However, when charging a battery pack the charging time (until the charging current falls to either 1C/20mA) will vary with the internal impedance of the battery pack and contact resistance of the battery terminals. The differences in charging time for different internal impedances and charging currents are indicated in Figures 34 and 35 respectively.

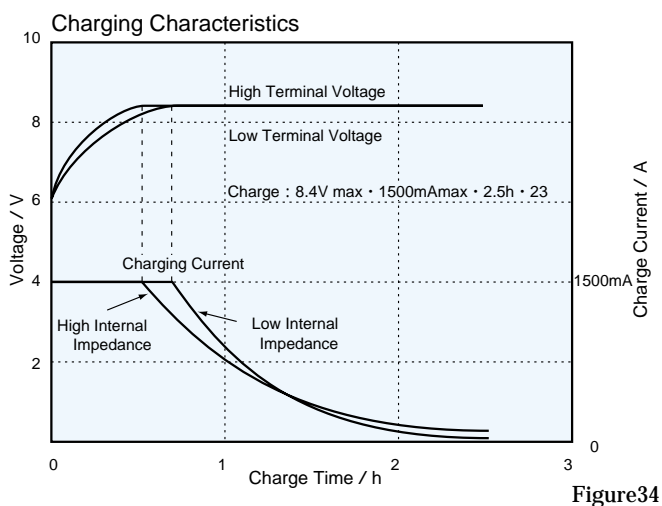

Figure34

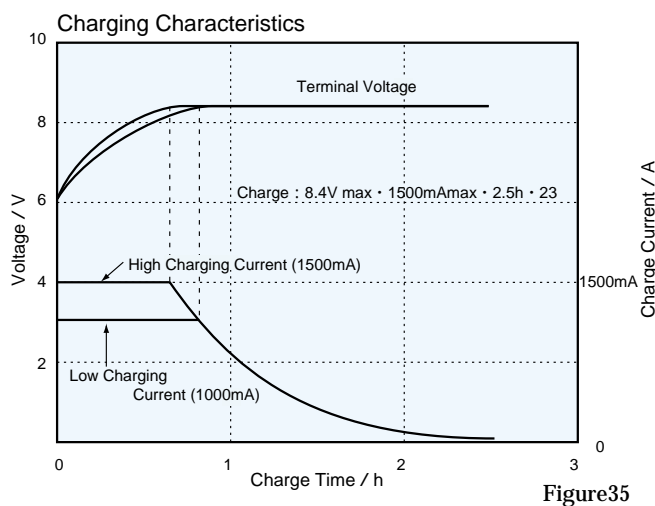

Figure35

5-3 Temperature range during charging: 0 to 45

5-3

Higher temperatures during charging may lead to battery degradation, whereas at lower temperatures the internal resistance of the battery will be increased, resulting in less charging and longer charging times. Charging should be performed within the above temperature range.

6 Precautions in Handling and Use

6-1 Precautions in handling

6

When using lithium ion rechargeable cells in a battery pack, please adhere to the following usage conditions.

6-1-1 Charging

6-1-1

Please use constant-voltage, constant-current charging at a charging voltage of 4.20 V/cell and charging current of from 0.2 to 1CmA. Please do not charge cells at voltages above 4.25 V/cell or at currents above maximum charging current.

Charging should be performed at temperatures in the range 0 to 45 °C, with batteries positioned such that they are not readily affected by any heating in the recharger. (Charging at temperatures above 45 °C will degrade battery performance.)

6-1-2 Discharging

6-1-2

Batteries should be discharged at maximum discharging current or less.

Please set the cutoff voltage at 2.5 V/cell or more.

Under no circumstances should overdischarge (to 1.0 V/cell or less) be allowed to occur.

Discharge should take place in an environment between -20 and 60 °C. (Below -20 °C, discharge capacity is severely reduced.)

6-1-3 Equipment design

6-1-3

- Do not apply solder directly to cells.
- Dedicated rechargers and load equipment should have constructions and terminal shapes such that batteries cannot be connected with polarities reversed.
- The construction and terminal shapes should be designed to prevent short-circuits by necklaces, paper clips and similar items.
- The construction and terminal shapes should be designed to prevent connection to other rechargers.
- The construction and terminal shapes should be designed such that the end user cannot easily use the battery to power other equipment.
- The battery should be located as far from any heat-generating areas of the equipment as possible.
- When using batteries with equipment which generates electromagnetic radiation, the protective circuitry should be positioned such that it is not readily affected, and any other appropriate measures should be taken.
- Equipment should have a shock-proof construction sufficient to ensure that, should the user drop the equipment or otherwise subject it to strong shocks, there is no breakage of wires in short-circuiting of cells in the battery pack, nor fluid leakage due to cell deformation.
- Battery packs and equipment should be designed to guard against the unlikely event of fluid leakage from cells.
- Protective circuits should be provided in at least one of, or in each of, the battery pack, load equipment and recharger.

The following three protective circuits are necessary.

a. Overcharge prevention circuit:

Activation voltage at the lower end of the range 4.25 to 4.30 V/cell

b. Overdischarge prevention circuit:

Activation voltage 2.0 to 3.0V/cell;
consumption current is less than a few μ A

c. Overcurrent prevention circuit:

Activation current approx. 3CmA

6-2 Precautions in use (primarily precautions for the end user)

6-2

Precautions and restrictions relating to the use of battery packs employing lithium ion rechargeable cells are described below.

6-2-1 Prohibitions relating to use

6-2-1

- Batteries should not be heated in microwave ovens, dryers or other device, or through into open flames.
- Batteries should not be left in an automobile in the hot sun, in direct sunlight, or wherever temperatures rise above 60 °C.
- Batteries should not be deformed, disassembled or modified.
- The positive and negative terminals of batteries should not be short-circuited with a metal object.
- Batteries should not be carried or stored with metal necklaces, paper clips, or other metal items.
- Batteries should not be allowed to get wet or be dropped into water or other liquids.
- Batteries should not be dropped, thrown, or subjected to other strong shocks.
- Under no circumstances should wires be soldered to battery terminals to enable use with other equipment.
- When batteries will be used as battery modules, please use batteries in same lots (Batteries of different lots must not be mixed in a same pack).
- Batteries should not be shorted between electrodes. If shorted, the battery should not be used.

Even if one of the above actions are accidentally committed, and there is no external abnormality, there may still be some internal malfunction which is not evident on casual inspection. In such cases, please bring the battery to a Sony service department for inspection.

6-2-2 Charging

6-2-2

Using the dedicated recharger, please charge the battery within the specified temperature range of 0 to 45 °C.

Under no circumstances should the battery be reverse-charged (with the battery connected to the recharger with polarities reversed).

6-2-3 Discharging

6-2-3

Batteries should be discharged in the load equipment within the specified temperature range of -20 to 60 °C.

Please do not use the batteries as a power supply for equipment other than the specified load equipment.

6-2-4 Storage

6-2-4

When batteries will not be used for an extended length of time, they should be discharged, removed from the equipment and stored in a dry, cool place (avoiding warm places) in order to prevent rusting and degradation of battery performance. When storing batteries for one year or longer, they should be charged at least once a year or so in order to prevent overdischarge caused by the protective circuitry.

6-2-5 Other matters

6-2-5

Soiling of battery terminals will worsen electrical contact with the recharger and the load equipment, and may hinder battery charging. Please use a clean cloth to wipe away any soiling prior to use.

Batteries have a limited lifetime. When the equipment operation time has shortened appreciably, the battery should be replaced. Do not dispose of batteries with ordinary garbage; either dispose of them according to the regulations in your area, or bring them to a Sony service department.

7 Safety Indications

In order to facilitate the safe use of lithium ion rechargeable batteries, below are summarized, as guidelines for indications and a related checklist, the essentials of the "Guidelines and Checklist for Indications to Ensure Safe Use of Storage Batteries," "Warning Indications to Prevent Shocks to Humans and Damage to Property," and "Indications for Safety Inspections" to maintain safety, published by the Battery Association of Japan. Please include any necessary items in the operation manual of load equipment using these batteries.

7-1 Basic approach to indications

7-1

The risk of harm to humans and damage to property is evaluated in terms of "probability of harm or damage" and "extent of possible harm or damage" in conformance with ANSI. In accordance with the Ministry of International Trade and Industry's guidelines, Ministry notice 6-230 (on product indications and the completeness and appropriateness of operation manuals), danger levels are classified into three levels--"danger," "warning" and "caution."

		Probability of Harm or Damage		
		High (probable)	Moderate (possible)	Low (hypothetical)
Extent of harm or damage	Death of the user	(not applicable)	Warning	
	Severe injury of the user	Danger		
	Mild injury of the user; damage to property	Warning	Caution	

Extent of harm or damage in the event of battery mishandling

*Danger: Cases in which death or severe injury is likely to result.

*Warning: Cases in which death or severe injury may possibly result, or mild injury or property damage frequently results.

*Caution: Cases in which there is no possibility of severe injury, but mild injury is possible, and when property damage alone is anticipated.

7-2 Objects of indications

7-2

Indications shall appear on the main units of storage batteries used as power supplies sold in Japan, on blister packs, product boxes, operation manuals, catalogs, and other applicable materials, with indications as shown below according to the danger level. In order to ensure greater safety, please include a consistent explanation of indications in operation manuals for equipment which uses storage batteries as a power supply.

Classification	Signal Word			Notes
	Danger	Warning	Caution	
Main unit				: Indication required
Blister pack				
Product box				: Indication optional
Operation manual				
Catalog etc.				

Indications are to employ four components as conforming to ISO3864 and ANSI Z 535.3, namely warning symbols, signal words, pictorials, and word messages.

Because JIS-Z9101 (1995 edition), "Safety Colors and Safety Signs" (warning symbols and pictorials) are also intended for use in industrial safety (traffic, mining, etc), "Danger Concepts" also include a high degree of danger (circles, red) and danger (diamonds, yellow); these however should be distinguished from the "danger level" based on mistaken handling in the field of consumer products of concern to the Battery Association of Japan.

7-4 Matters for indication

The types of injury and damage that may arise from misuse of battery packs, how best to avoid such injury or damage, and what steps to take should such damage or injury occur, were studied in detail for each category of product use; the following summarizes indications prompting the user to specific actions to prevent or avoid such damage or injury.

Category of Product Use		Matters for Indication	Danger Level
1. Purchase	1. Limits on usage environment	<ul style="list-style-type: none"> • The temperature range for battery charging is 0 to 45 . Outside this temperature range, batteries may leak or generate heat, and battery performance or lifetime may be degraded. • Batteries must not be wetted or immersed in water or brine. Damage to the battery and degradation of performance or lifetime may result. • Batteries must not be exposed to strong sunlight, left in vehicles in the hot sun, or used or left in other hot places. Heating, ignition, and degradation of performance or lifetime may result. • Batteries must not be used or left near flames, stoves, or in other hot places. Heating or ignition may result. 	Caution Caution Caution Danger
	2. Limits on conditions of use	<ul style="list-style-type: none"> • Batteries must either be charged using the dedicated recharger, or must be charged under the specified conditions. If batteries are charged under other conditions, battery heating, ignition or rupture is possible. 	Danger
3. Preparation for use	1. Request to read the operation manual	<ul style="list-style-type: none"> • Instructions or warnings should be read before using the battery. Moreover, instructions should be saved so that they can be read when necessary. • Carefully read the operation manual for the dedicated recharger before charging the battery. 	Caution Caution

Category of Product Use		Matters for Indication	Danger Level
3. Preparation for use	4. Restraints and prohibitions relating to power supply connections	<ul style="list-style-type: none"> • When connecting batteries to the recharger or equipment, be sure the + and - terminals are correct. Do not forcibly connect the battery, or battery heating, ignition and rupture may result. • Do not connect the battery to a power outlet or to the cigarette lighter of a vehicle. Heating, ignition and rupture may result. 	<p>Danger</p> <p>Danger</p>
	5. Inspection of the product prior to use	<ul style="list-style-type: none"> • On using the battery for the first time, if it appears to be rusted, gives off an odd smell, gives off heat, or otherwise behaves strangely, do not use it, but bring it to the store from which it was purchased. 	Caution
4. Uses other than the intended use	1. Unintended uses	<ul style="list-style-type: none"> • This battery is for use only with _____. If it is used with other equipment, battery damage and degradation of performance or lifetime may result. 	Danger
5. Method of use	2. Requests made of the parent or guardian of the user	<ul style="list-style-type: none"> • When a child is to use the battery, the child's parent or guardian should explain the contents of the operation manual to the child. The parent or guardian should also make sure that the child is using the battery as explained in the operation manual. • The equipment and battery should be placed out of the reach of children to prevent children from accidentally swallowing small batteries. Should a battery be swallowed, immediately seek medical attention. • Batteries should be stored out of the reach of small children. When in use, care should be taken to ensure that small children cannot remove batteries from the recharger or the equipment. 	<p>Caution</p> <p>Warning</p> <p>Caution</p>
	4. Prohibition of anticipated misuse	<ul style="list-style-type: none"> • When using batteries, always obey the following rules. Failure to obey these rules may result in battery heating, ignition or rupture. *Do not throw batteries into fires or heat them. *Do not reverse the battery + and - terminals. *Do not use a wire or other metal object to connect the battery + and - terminals. Do not carry or store batteries together with metal necklaces or other metal objects. *Do not puncture batteries with nails, strike them with hammers, step on them, or apply solder to them. *Do not place batteries in microwave ovens or pressure cookers. *Do not use batteries together with dry cells or other nonrechargeable batteries, or with batteries with different capacities, of different types or brands. *Do not throw batteries or subject them to strong shocks. 	<p>Danger</p> <p>Danger</p> <p>Danger</p> <p>Danger</p> <p>Danger</p> <p>Warning</p> <p>Warning</p> <p>Caution</p>

Category of Product Use		Matters for Indication	Danger Level
5. Method of use	6. Prohibition of modification and other special uses	*Batteries are provided with protective devices to prevent dangerous situations, and therefore must not be disassembled or modified. The protective device may be destroyed, and battery heating, ignition or rupture may result.	Danger
	7. Prohibition of uses leading to degraded safety	*Batteries must not be charged near flames, in the hot sun or in similar conditions. If they become hot, a protective device to prevent dangerous situations may be activated, preventing battery charging, or the protective device may be destroyed, and battery heating, ignition or rupture may result.	Danger
7. Response to abnormal behavior	1. Prohibition of use in the event of faulty or abnormal behavior	*During the use, charging or storage of batteries, if strange smells, heating, changes in color, deformation or other strange circumstances occur, the battery should be removed from the equipment or recharger, and should not be used. *During charging, if charging is not completed within the prescribed charge time, charging should be stopped. If not stopped, battery heating, ignition or rupture may result.	Warning Warning
	2. Measures to take in the event of abnormal behavior	*Should fluid leaked from a battery come in contact with skin or clothing, the affected skin may be affected, and should be washed with water immediately. *Should fluid enter the eyes, damage may result; the eyes should be washed with water immediately, and medical attention sought. *If batteries leak fluid or give off strange smells, they should immediately be removed from the vicinity of any open flames. Leaking electrolyte may catch fire, causing ignition and rupture.	Caution Warning Warning
9. Product disposal	1. Parts to be removed	*Used batteries should have their terminals covered with tape or other material for insulation prior to disposal.	Caution

8 Indications on Acquisition of Safety Certification

Lithium ion rechargeable batteries have received UL certification (UL file No. MH12566). When using these batteries with UL-certified equipment, a UL evaluation must be obtained, and any indications must conform with UL standards.

8-1 Indications for UL1642 Lithium Batteries standards

8-1

Requirements are described in the "Conditions of Acceptability" in "UL Procedure."

8-1-1 Indications on battery pack

8-1-1

The specified indication must appear on battery packs using lithium ion rechargeable cells. In addition, there are also battery-related requirements in standards for equipment using battery packs, and these equipment standards must be obeyed.

Example: Caution indication for battery packs used with information equipment (UL1642 and UL1950 1.7.17)

CAUTION:

- A) The battery in the device may present a fire or chemical burn hazard if mistreated.
- B) Do not disassemble, heat above 60°C (140°F), crush, puncture, short external contacts or incinerate.
- C) Replace battery with (Battery brand name and Model name) only.
- D) Use of another battery may present a risk of fire or explosion.
- E) Battery pack is suitable for use only with (End product name).
- F) Dispose used batteries according to the manufacturer's instructions.
- G) Keep away from children.

When all the above indications cannot be included on the battery pack itself, A), B), and "See owner's manual for safety instructions" should be displayed, and items from C) to G) should be printed in the operation manual for the battery pack.

8-1-2 Caution indication for equipment using battery pack.

8-1-2

Indications similar to those on the battery pack must also appear in the operation manual for the equipment.

8-2 CSA and EN standards

8-2

Because there are no provisions for lithium ion rechargeable batteries in CSA and EN standards, indications should be provided according to requirements for batteries in the standards for the equipment item 1.7.17.

Example: For information equipment, CSA C22.2 No. 950 and EN60950 are designed for coordination of standards, and so as with UL certification, French and German indications should be included.

When there are conditions imposed on indications, such as the application of the battery pack or the area of the indication, please consult with Sony.

9 Glossary

Safety vent	The safety vent is activated when the internal pressure exceeds a specified value, to release carbon dioxide or other gas. In addition to preventing outside air from entering through the vent, battery rupture caused by increases in internal pressure due to generation of gas during charging is prevented.
Secondary battery	Battery that can be reused after it is charged. There are Ni-Cd and Ni-MH rechargeable carbon batteries in addition to Li-ion rechargeable battery.
Active material	The electrochemically reactive material of the electrodes. Cathodes use lithium cobaltate; anodes employ hard carbon or graphite.
Separator	A microporous thin film inserted between cathode and anode to prevent short-circuits and maintain spacing. Polyethylene film, polypropylene film, or other film is used.
Cathode	An electrode at higher potential than the anode, passing electric current to the outside circuit during discharge.
Anode	An electrode at lower potential than the cathode, into which current flows from an external circuit during cell discharge.
Cell	Individual batteries comprising a battery pack.
Battery modules	Battery concerning of at least two cells.
Electrolyte	The medium in which lithium ions are transported during electrochemical reactions within the cell. In lithium ion batteries, the electrolyte is LiPF_6 dissolved in an organic solvent generally.
Energy density	The amount of energy that can be extracted per unit battery weight, or per unit battery volume. Expressed in units of Wh/kg or Wh/l.
Open circuit voltage (OCV)	The voltage of the battery when it is disconnected electrically from outside circuits.
Closed circuit voltage (CCV)	The voltage of the battery when it is connected electrically to an outside circuit.
Charge-discharge cycle	Method of using a battery. In this method, charging and discharging are repeated.

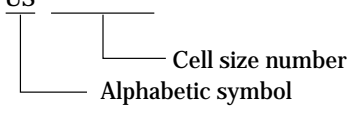
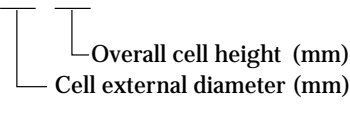
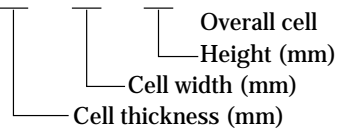
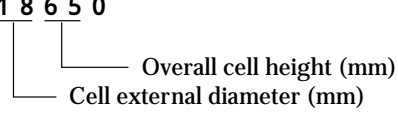
Overcharge	Charging the battery after it has reached the fully-charged state. If a battery is overcharged, lithium metal is precipitated on the anode surface, and the battery becomes extremely chemically unstable.
Overdischarge	Discharging the battery after the voltage has fallen below the specified cutoff voltage. If a battery is overdischarged, the anode current collector copper is dissolved.
Nominal capacity	Capacity used to represent a battery capacity.
Nominal voltage	The voltage used in battery indications. A value close to the normal discharge voltage. 3.6V for hard carbon anode batteries, 3.7V for graphite anode batteries.
C	Used to express the magnitude of the charge or discharge current; expressed as a multiple of the battery rated capacity multiplied by the current. In general the charge or discharge current is expressed as a multiple of C. For instance, for a battery of rated capacity 1500 mAh, 0.2 C mA = 0.2 x 1500 = 300 mA
Self-discharge	Reduction of the battery capacity when no current is flowing to an external circuit.
Cut off voltage	The limiting voltage which terminates discharge. This voltage generally corresponds to the lower usable voltage limit.
US	<p>US</p>  <p>Cell size number Alphabetic symbol</p> <p>The meaning of cell size number</p> <p>Cylindrical shape</p>  <p>Overall cell height (mm) Cell external diameter (mm)</p> <p>Prismatic shape</p>  <p>Overall cell Height (mm) Cell width (mm) Cell thickness (mm)</p> <p>Example</p> <p>1 8 6 5 0</p>  <p>Overall cell height (mm) Cell external diameter (mm)</p>

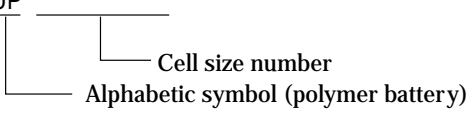
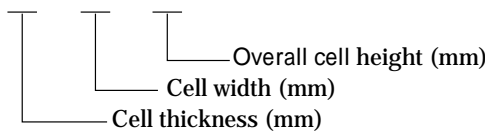
UP	<p>UP</p>  <p>Cell size number Alphabetic symbol (polymer battery)</p> <p>The meaning of cell size number</p>  <p>Overall cell height (mm) Cell width (mm) Cell thickness (mm)</p>
Discharge capacity	Capacity that can be taken out when the battery is discharged. The unit is mAh(mili-ampere-hour)
Initial capacity	Discharge capacity on full charging at time of shipment
Remaining capacity	Usually, the remaining capacity represents the capacity left in the battery after it is partially discharged or stored for a long period of time.
Rated capacity	Reference value representing the battery discharge capacity. In general, capacity guaranteed at 0.2CmA discharge.
Memory effect	Phenomenon in which repetition of charge-discharge cycle with a shallow discharge depth causes a temporary drop in the operating voltage. When compared to the rated capacity, the capacity drop is small. However, since the voltage between the battery terminals drops, the operation time of the set may be affected if a high end voltage is set.
0.2CmA discharge current	When stipulating the discharge current for 5 hour discharge conditions and the cell standard capacity, 0.2CmA discharge conditions are assumed.
Leakage of electrolyte	Phenomenon in which electrolyte leaks to external surfaces of the battery. Even when electroytes leaks slightly, battery terminals are dirtied and corroded, resulting in poor contacts and operation failures. If much electrolyte leaks, the battery capacity drops.

10 Sales Office

Head Office

Sony Corporation
Electric Device Marketing Dept.
Core Technology & Network Company
Device Dept., Computer Network Marketing Div.
Phone:03-5435-3279 Fax:03-5435-3327
Mobile & IT Marketing Dept., Mobile & Public Marketing Div.
Phone:03-5435-3277 Fax:03-5435-3328
Visual Marketing Dept., Home AV Marketing Div.
Phone:03-5435-3295 Fax:03-5435-3463

Osaki West Technology Center

Gate City Osaki West Tower, 1-11-1, Osaki Shinagawa-ku, Tokyo, 141-0032 Japan

Sales Office

United States

Sony Electronics Inc., USA
Address: 3300 Zanker Road, M/S: SJ2A12, San Jose, CA95134-1901 U.S.A
Telephone: +1-408-955-4054
*Regarding inquiries about batteries and battery packs for Sony consumer products available in the U.S., please contact Customer Information shown below.
Voice: +1-800-488-7669
Fax: +1-941-768-7790

Taiwan

Sony Taiwan Limited Li-ion Battery Marketing Company Taiwan
Address: Chia Hsin Sec. Bldg., 6 Floor, Rm 611, 96 Chung Shan N. RD., Sec.2, Taipei, Taiwan R.O.C.
Telephone: +886-2-2541-1080

Korea

Lithium-ion Battery Team
Electronic Devices Marketing Korea
(A Division Company of Sony Korea Corp.)
Address: 34F, ASEM Tower, World Trade Center, 159-1, Samsung-Dong, Kangnam-Ku, Seoul, 135-798 Korea
Telephone: +82-2-6001-4268 (Marketing)
Telephone: +82-2-6001-4252 (Technology Center)

U.K.

Sony Semiconductor & Devices Europe
Sony Core Technology & Network Company Europe
(A Division of Sony United Kingdom Limited)
Address: The Heights, Brooklands, Weybridge, Surrey KT13 OXW, U.K.
Telephone: +44-1932-816-000

China

Sony China Shanghai Office Battery Products Division
Address: 43F HSBC Tower, 101 Yin Cheng East Road, Pudong New Area, Shanghai 200120, P.R. China
Telephone: +86-21-6841-4893

Denmark

Sony Semiconductor & Devices Europe, Copenhagen Office
Address: Hoersvinget 1, Postbox 154, DK-2630 Taastrup, Denmark
Telephone: +45-4355-7000

France

Semiconductor & Devices Europe, Paris Office
Address: 26 rue Morel, 92110 CLICHY, France
Telephone: +33-1-5590-3663

Germany

Semiconductor & Devices Europe, Munich Office
Address: Max-Planck-Strasse 8, D-85609 Aschheim Dornach, Munich, Germany
Telephone: +44-89-945820